

Tru-Test.
DATAMARS

Speedrite.
DATAMARS

Patriot.
DATAMARS

**Z
TAGS.**
DATAMARS

njphillips.
DATAMARS

Simcro.
DATAMARS

Animal Health

Delivery Systems

Animal Health Solutions
PRODUCT GUIDEBOOK

A Measurable Difference

We are dedicated to providing a more comprehensive, integrated livestock management portfolio. As a result, we have united our product brands under a single family – Datamars Livestock.

Our goal is to provide producers with the essential tools to meet the increasing global demand for high-quality protein. The journey begins with tag identification at birth. As animals grow, our products meticulously track data insights, facilitating fact-based decision-making. Our animal health delivery systems ensure dose accuracy, safety, and efficiency, thereby saving time and reducing stress. Taking it a step further, our line of livestock scales and EID readers collect real-time data for effective management throughout the animal's life cycle.

With a strong track record of partnering globally with the pharmaceutical industry on confidential and market-sensitive projects, our collaborative and professional approach has earned us exceptional customer retention. Through stringent quality standards and innovative development, NJ Phillips and Simcro product lines enhance the value of pharmaceuticals and vaccines for production livestock. Our product hallmarks include dose accuracy, user safety, operational convenience, and animal welfare. During the design stage, our engineers consider end-user environments to manage health, safety, and animal welfare risks. All products undergo rigorous testing in both field trials and our in-house laboratories. Integrity is fundamental to our design, ensuring that customers receive an uncompromising end product. Our specialty packaging can be tailored to meet specific brand requirements.

At Datamars Livestock, we take pride in delivering quality products and exceptional service. We believe in the future of agriculture and are ready to assist with any challenges at hand.

NJ Phillips & Simcro Animal Health Delivery Systems

VISIT NJPHILLIPS.COM
VISIT SIMCRO.COM

Speedrite Superior Electric Fencing

VISIT SPEEDRITE.COM

Patriot Quality Electric Fencing

VISIT PATRIOTGLOBAL.COM

Z Tags & Temple Tag Livestock Identification Tags

VISIT ZTAGS.COM

Tru-Test Weighing & EID Stick Readers

VISIT TRU-TEST.COM

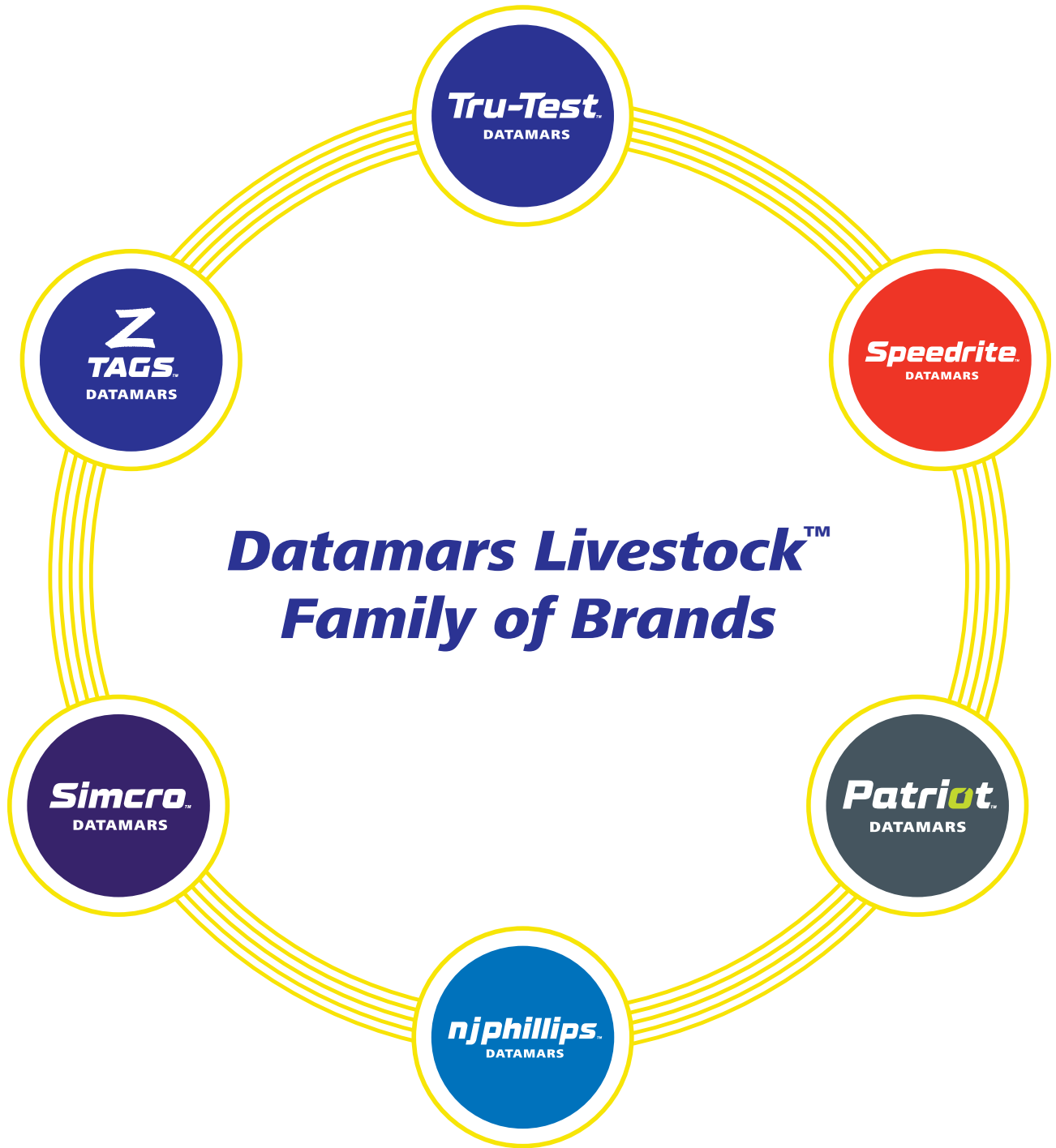

CONTENTS

Terminology	5
Tube Fed & Bottle Mount Injectors	6
Tube Fed Injector Accessories	8
Bottle Mount Injector Accessories	9
Assembly Instructions	10
VS Injectors	12
VS Injector Accessories	14
Assembly Instructions	16
Dose Conversion Kits	17
Repeater Syringes	18
Repeater Accessories	20
Assembly Instructions	21
Nylon Syringes	22
Backpack Solutions	23
Pour-on & Oral Drenchers	24
Disposable Needles & Syringes	26
Production Products	32
Production Products Accessories	33
Assembly Instructions	34
Choosing the Correct Needle & Syringe	35

We empower producers by enabling data-driven decisions, ensuring consistent and profitable results. We support you through everyday livestock production needs, with innovative technology aiding day-to-day tasks. Our tools enhance animal health, precision management, and protein production, working seamlessly together and with you. Whether in the field or online, our digital platform provides real-time livestock information, enhancing decision-making. Our products not only work together but, more importantly, work for you.

Datamars Livestock, a division of the global company Datamars, Inc., is a leading provider of precision livestock management solutions. Our top-quality tools, including Tru-Test, Z Tags, Patriot, and others, support efficient and profitable livestock management. Backed by the Datamars Livestock cloud software, our products offer real-time data for producers.

VISIT [LIVESTOCK.DATAMARS.COM](https://www.datamars.com/livestock)



TERMINOLOGY

Barrel: The part of an injector which functions to measure and contain the medication fluid. The plunger forces fluid through the barrel and out through the needle.

Fixed Dose: The device has a single fixed dose option on the indicator window. A dose selector is present on the device, but it cannot be adjusted or moved.

Forward Selectable: The non-slip selector enables easy and accurate dose selection, preventing product loss when adjusting the dose setting. When smaller dose sizes are selected, the plunger moves further forward along the barrel. It uses a positive stroke to displace the entire dose in the barrel, ensuring accuracy and maximum efficacy. This configuration reduces bubbles and quickly removes them from the system, ensuring accuracy and efficacy.

Oral Drencher Application: Administering medicine dosage or liquid preparations directly into an animal's stomach by mouth is commonly known as drenching. This method is widely used for various treatments, including worm remedies (anthelmintics), addressing conditions like bloat, diarrhea, constipation, and other medicinal applications.

PLT Needle Connection: A platelet count (PLT) test assesses the quantity of platelets in the blood. Platelets, also known as thrombocytes, are cells produced in bone marrow. Its crucial role involves clotting the blood in response to damage to a blood vessel wall, preventing excessive bleeding.

Polypropylene Plastic Barrel: Some injectors offer optional polypropylene plastic barrels for use with medications requiring increased chemical resistance. These barrels have a "cloudy" appearance and are less transparent, however they can handle harsh medications.

Polysulfone Plastic Barrel: Most injectors come standard with a barrel made of polysulfone plastic which is compatible with most medications except those requiring increased chemical resistance. These barrels have the benefit of being more transparent for easy volume reading.

Pour-on Application: For thinner medications that absorb into the skin and are generally applied along the back of an animal. Comes off in a spray-like manner for quick, easy, and safe application. It does not require animals to be contained.

Reverse Selectable: The non-slip selector enables easy and accurate dose selection, preventing product loss when adjusting the dose setting. Once the dose is selected, the plunger will remain at the back of the barrel. At low doses, the plunger acts on a full barrel, making the air in the system challenging to purge as air bubbles compress rather than expel. If bubbles go unnoticed, they can lead to the animal's underdosing and reduce efficacy.

Selectable Repeaters: Device has a dial that can be adjusted to pre-set dose size, the plunger moves towards the end of the barrel while each dose is administered and fully emptying the barrel at which point it can be refilled.

Variable Dose: Allows precise dosage selection and flexible adjustment without the need to change syringes or applications. It allows for quick and easy switching between doses, with fine-tuning against the plunger and barrel markings as needed.

Variable Lock: The non-slip selector allows easy, accurate dose choice and flexible dose adjustment. Variable lock dose selection can be fine-tuned against the front of the plunger and dose indication markings on the barrel (unless otherwise stated on the device).

Tube Fed & Bottle Mount Injectors

njphillips
DATAMARS

Simcro
DATAMARS

Designed with a textured non-slip finish, our bottle mount and tube-fed injectors feature an ergonomic grip, reducing hand strain during prolonged use. The simple yet precise dose selection includes an easy-grip volume control for accuracy. Available dose control settings include fixed, variable, reverse selectable, and forward selection, providing versatility when administering vaccinations. Most of our injectors come with three draw-off cap sizes and a tube to fit most 50mL – 500mL bottle sizes (refer to the description of each injector for specific details). Constructed with strong, durable material, they ensure long-lasting performance.

Metal injectors are exceptionally robust, offering maximum durability and reliability in any environmental conditions. They are highly accurate and versatile, with easy-to-read barrel dose gradations. The superior ergonomic design features an easy-to-push handle for prolonged use across a variety of livestock.

Compact injectors are both durable and economical. This award-winning design offers variable dose control selection and is easily interchangeable from a tube-fed to a bottle mount. Designed to be compatible with our topical pour-on and oral drench nozzles, it comes in three dose range sizes. For assembly instructions, see page 10.

Features & Benefits:



COMFORTABLE
GRIP HANDLE



DOSE
ACCURACY



TEXTURED
NON-SLIP FINISH



VERSATILITY



DURABILITY

TUBE FED INJECTORS

**PREMIUM
0.8mL Fixed
Tube Fed Injector**



Dose Range: 0.8mL
Dose Increments: 0.8mL
Includes: 33mm Draw-off Cap; Tube

850 0000-090

**PREMIUM
1mL Fixed
Tube Fed Injector**



Dose Range: 1mL
Dose Increments: 1mL
Includes: 20mm, 27mm & 33mm
Draw-off Caps; Tube

850 0000-031

**PREMIUM
2mL Fixed
Tube Fed Injector**



Dose Range: 2mL
Dose Increments: 2mL
Includes: 20mm, 27mm & 33mm
Draw-off Caps; Tube

850 0000-001

**PREMIUM
2mL Variable
Tube Fed Injector**



Dose Range: 0.2mL – 2mL
Dose Increments: 0.2mL
Includes: 20mm, 27mm & 33mm
Draw-off Caps; Tube

850 0000-002
850 0000-356 Service Kit

**PREMIUM
5mL Forward Selectable
Tube Fed Injector**



Dose Range: 0.5mL – 5mL
Dose Increments: 0.5mL
Includes: 20mm, 27mm & 33mm
Draw-off Caps; Tube

380 0012-131
850 0000-352 Service Kit

**PREMIUM
10mL Variable
Tube Fed Injector**



Dose Range: 1mL – 10mL
Dose Increments: 1mL
Includes: 20mm, 27mm & 33mm
Draw-off Caps; Tube

850 0000-024

**PREMIUM
12mL Hi-Viscosity Reverse
Selectable Tube Fed Injector**



For dense medications.
Dose Range: 2.5mL – 12mL
Dose Increments: 0.5mL
Includes: 20mm, 27mm & 33mm Draw-off Caps; Tube

850 0000-003

**2mL Sekurus™ Reverse
Selectable Tube Fed Injector**



Patented Technology.
Dose Range: 0.5mL – 2mL
Dose Increments: 0.5mL
Includes: 20mm, 27mm & 33mm Draw-off Caps; Tube;
16G 3/4" Detectable Needle

850 0000-008

**12mL Sekurus™ Reverse
Selectable Tube Fed Injector**



Patented Technology.
Dose Range: 2.5mL – 12mL
Dose Increments: 0.5mL
Includes: 20mm, 27mm & 33mm Draw-off Caps; Tube;
16G 1/2" Detectable Needle

850 0000-009

**1mL Automatic Metal
Variable Tube Fed Injector**



Dose Range: 0.1mL – 1mL
Dose Increments: 0.1mL
Includes: Tube; Lubricant Bottle

850 0000-110
50 0001-326 SERVICE KIT

**2mL Automatic Metal
Variable Tube Fed Injector**



Dose Range: 0.2mL – 2mL
Dose Increments: 0.2mL
Includes: Tube; Lubricant Bottle

850 0000-012
850 0000-142 SERVICE KIT

**5mL Automatic Metal
Variable Tube Fed Injector**



Dose Range: 0.5mL – 5mL
Dose Increments: 0.5mL
Includes: Tube; Lubricant Bottle

850 0000-013
850 0000-055 SERVICE KIT

COMPACT
1mL Variable Tube Fed Injector



Dose Range: 0.1mL – 1mL
Dose Increments: 0.1mL
Includes: 20mm, 27mm & 33mm Draw-Off Caps; Tube
850 0000-016

COMPACT
2mL Variable Tube Fed Injector

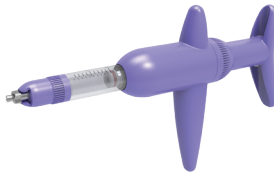

Dose Range: 0.2mL – 2mL
Dose Increments: 0.2mL
Includes: 20mm, 27mm & 33mm Draw-Off Caps; Tube
850 0000-017

COMPACT
5mL Variable Tube Fed Injector



Dose Range: 0.5mL – 5mL
Dose Increments: 0.5mL
Includes: 20mm, 27mm & 33mm Draw-Off Caps; Tube
850 0000-018

PREMIUM
20mL Metal Variable Tube Fed Oral Drencher



Dose Range: 1mL – 20mL
Dose Increments: 1mL
Includes: 4" Nozzle; 6" Nozzle; Tube; Luer Mount with Needle Nuts (x2); Inlet Fitting; Needle Hub Spanner; Tube Fed Adaptor Kit; Lubricant
850 0000-011

PREMIUM
15mL Selectable Tube Fed Injector



Dose Range: 5.5mL – 15mL
Dose Increments: .5mL
Includes: 20mm, 27mm & 33mm Draw-Off Caps; Tube
850 0000-033

TUBE FED ACCESSORIES

2mL Metal Automatic Tube Fed Major Kit

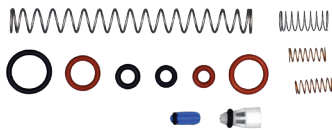

Includes: Cylinder (Barrel); (4) O-rings; Values & Springs; Return Spring
850 0000-142

5mL Metal Automatic Tube Fed Major Kit



Includes: Cylinder (Barrel); O-ring; Piston Washer; Cup Support Washer; Head Seal Washer
850 0000-055

PREMIUM
2mL Variable Tube Fed Major Kit

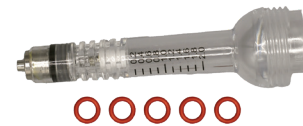

Includes: 2mL Barrel; (5) Spare O-rings
850 0000-356

PREMIUM
5mL Forward Selectable Tube Fed Major Kit



Includes: 5mL Barrel; (5) Spare O-rings
850 0000-352

27mm Vented Draw-off Cap



850 0000-098

Spare Draw-off Kit with Tube

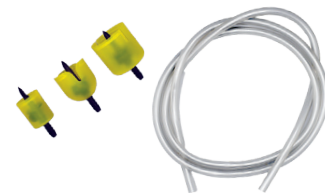

Includes: 5ft Tube; 20mm Draw-off Cap; 27mm Draw-off Cap; 33mm Draw-off Cap
850 0004-384

BOTTLE MOUNT INJECTORS

**PREMIUM
0.5mL Forward Selectable
Bottle Mount Injector**



Dose Range: 0.1mL – 0.5mL
Dose Increments: 0.1mL
Includes: 100mL Bottle Shroud;
Large Bottle Adapter

850 0000-004
850 0000-350 SERVICE KIT

**PREMIUM
2mL Forward Selectable
Bottle Mount Injector**



Dose Range: 0.1mL – 2mL
Dose Increments: 0.1mL
Includes: 100mL Bottle Shroud;
Large Bottle Adapter

850 0000-007
850 0000-349 SERVICE KIT

**PREMIUM
5mL Variable
Bottle Mount Injector**



Dose Range: 0.5mL – 5mL
Dose Increments: 0.5mL
Includes: 100mL Bottle Shroud;
Large Bottle Adapter

850 0000-023
850 0000-355 SERVICE KIT

**5mL Compact Variable
Bottle Mount Injector**

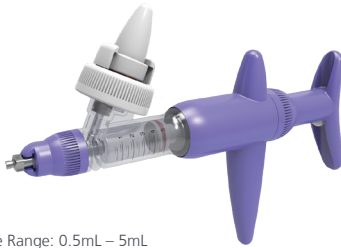

Dose Range: 0.5mL – 5mL
Dose Increments: 0.5mL
Includes: 20mm Small & 30mm Large Bottle Adapter

850 0000-020

**0.5mL Bottle Mount
Variable (BMV) Injector**



Dose Range: 0.1mL – 0.5mL
Dose Increments: 0.1mL
Includes: 20mm Small Bottle Adapter

850 0000-021

**2mL Bottle Mount
Variable (BMV) Injector**



Dose Range: 0.2mL – 2mL
Dose Increments: 0.2mL
Includes: 20mm Small & 30mm Large Bottle Adapter

850 0000-025

**6mL Bottle Mount
Variable (BMV) Injector**



Dose Range: 0.5mL – 6mL
Dose Increments: 0.5mL
Includes: 20mm Small & 30mm Large Bottle Adapter

850 0000-022

BOTTLE MOUNT ACCESSORIES

**PREMIUM
0.5mL Forward Selectable
Major Kit**



Includes: 0.5mL Barrel; (5) Spare O-rings

850 0000-350

**PREMIUM
2mL Forward
Selectable Major Kit**



Includes: 2mL Barrel; (5) Spare O-rings

850 0000-349

**5mL Variable Bottle Mount
Major Kit**



Includes: 5mL Bottle Shroud; (5) Spare O-rings

850 0000-355

ASSEMBLY INSTRUCTIONS

Fixed Instructions:

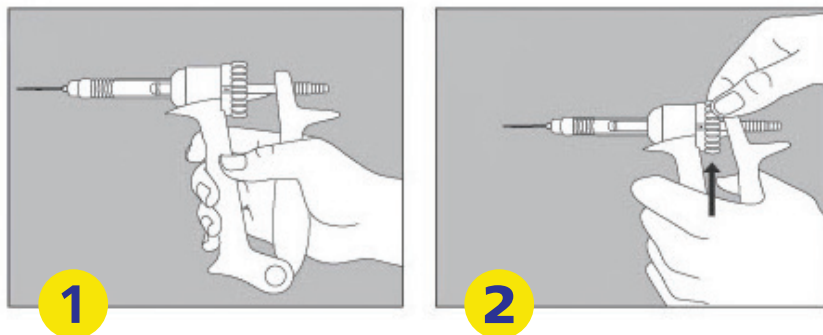

(1) Device has one fixed dose option printed on the indicator window. (2) Dose selector is present on the device but cannot be moved.

Variable Instructions:

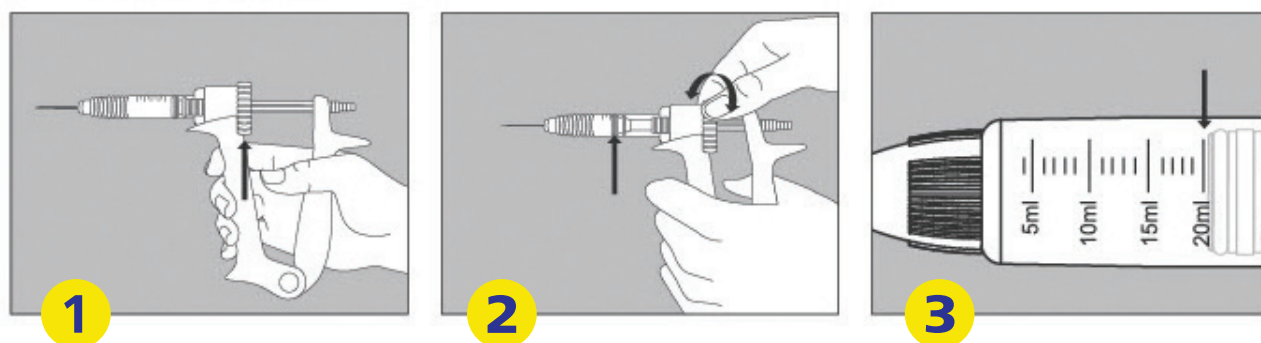

To set the dose, rotate the dose selector (1) either clockwise or counterclockwise until the front of the plunger aligns with the required dose marked on the barrel (2-3).

Forward Selectable Instructions:

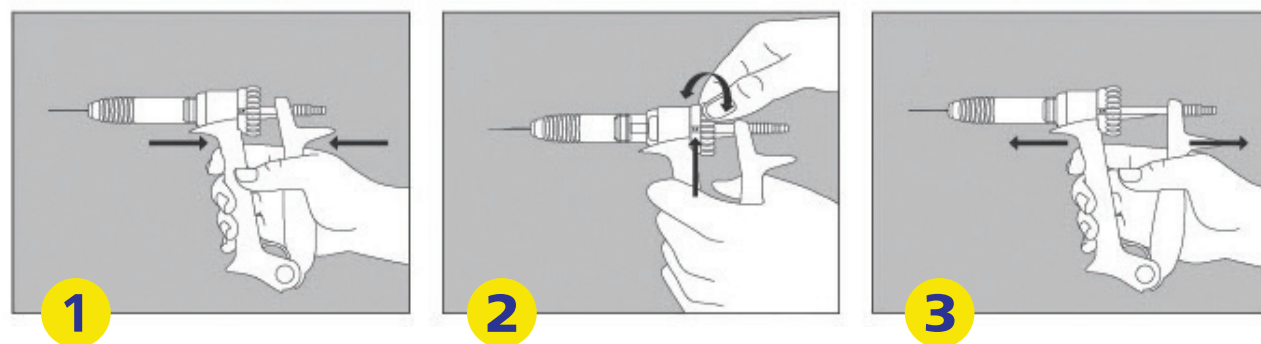

To set the dose, squeeze the injector handles (1). Then, turn the dose selector clockwise or counterclockwise until the desired dose is visible in the dose window (2). Once the required dose is displayed, release the injector handles to open them as usual (3).

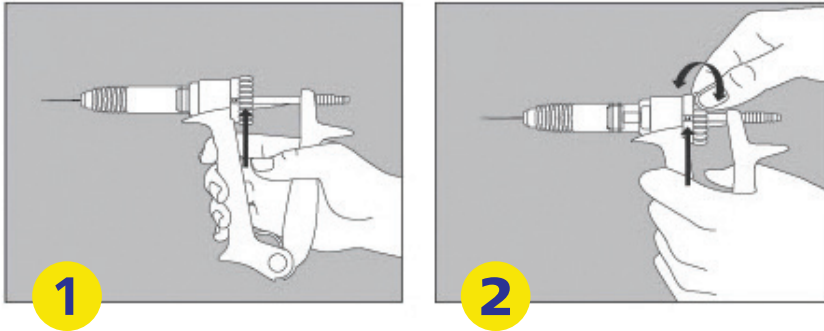
Reverse Selectable Instructions:

To set the dose, rotate the dose selector (1) either clockwise or counterclockwise until the desired dose is visible in the dose window (2).

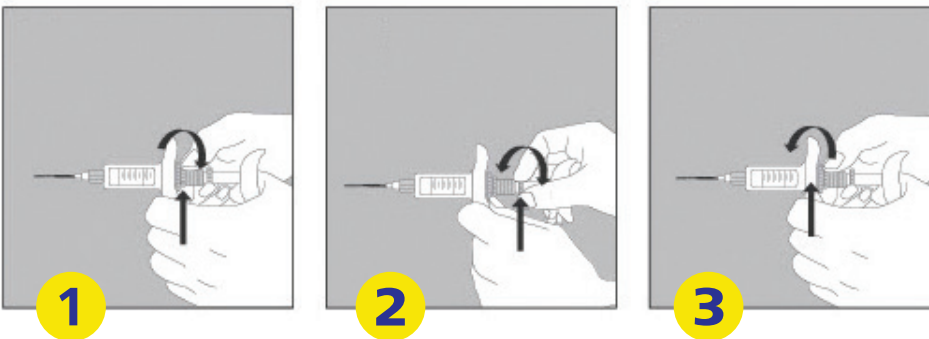
Nylon Syringe / Variable Lock Instructions:

To set the dose, first, turn the nut lock counterclockwise. Then, (2) rotate the dose selector either clockwise or counterclockwise until the front of the plunger aligns with the required dose indicated on the barrel. Finally, turn the nut lock clockwise to secure the dose setting (3).

VS Injectors

2mL & 5mL

njphillips.
DATAMARS

Simcro.
DATAMARS

The ultimate all-in-one injector

The VS Injector is designed with ultimate flexibility for cattle producers. Packed with features to protect both people and livestock, it delivers accurate fixed-dose volumes safely and effectively. The ergonomic design provides a comfortable grip for sustained use. This assembly is adaptable, transitioning seamlessly from a bottle mount to a tube-fed injector. Interchangeable dose chambers are available in 0.5mL, 1mL, 2mL, and 5mL sizes, each easily identifiable by its color-coded ID band. It adheres to treatment protocols by providing accurate and precise fixed doses for a variety of vaccines and medications. The entire injector can be boiled to meet sterilization protocols, ensuring sanitation and food safety standards are met. Color ID bands simplify matching the injector to a specific treatment. Easily administer subcutaneous and intramuscular injections to comply with Beef Quality Assurance (BQA) requirements, promoting animal well-being.

For assembly instructions, see page 16.

Features & Benefits:



ERGONOMIC
DESIGN



VERSATILITY



COMPLIANCE



IDENTIFICATION
BANDS



ANIMAL
WELL-BEING



SANITATION &
FOOD SAFETY

VS INJECTORS

2mL Fixed Dose VS Injector
Non Needle Guard



Includes: Non-needle Guard Assembly; (3) Draw-off Caps; (2) Needle Removal Tools; (4) Color ID Bands

850 0005-110

5mL Fixed Dose VS Injector
Non Needle Guard



Includes: Non-needle Guard Assembly; (3) Draw-off Caps; (2) Needle Removal Tools; (4) Color ID Bands

850 0005-111

VS INJECTOR ACCESSORIES

Multicolored Ink Stamps (5pk)



850 0004-304

Red Ink Stamp

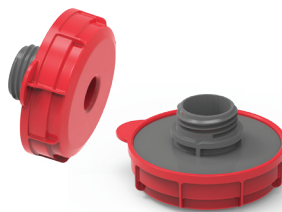

850 0004-299

Blue Ink Stamp

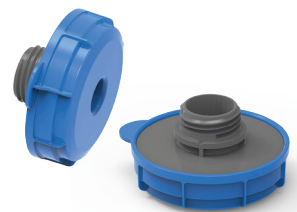

850 0004-300

Green Ink Stamp

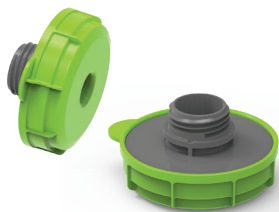

850 0004-301

Purple Ink Stamp

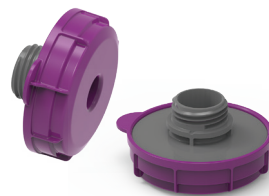

850 0004-302

Yellow Ink Stamp

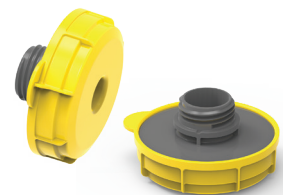

850 0004-303

VS INJECTOR ACCESSORIES

Non-Needle Guard Assembly

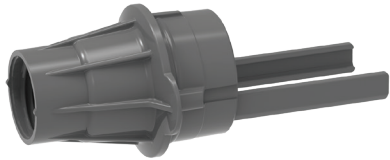

850 0004-140

0.1mL – 1mL Valve Assembly Kit



Includes: (2) valves; 15mL lubricant

850 0004-138

2mL – 5mL Valve Assembly Kit



Includes: (2) valves; 15mL lubricant

850 0004-139

100mL Bottle Mount Shroud



850 0004-142

1" Needle Guard Assembly



850 0004-315

1.5" Needle Guard Assembly



850 0004-316

Needle Guard Front Cap



850 0004-317

Red ID Color Band Ring



850 0004-318

**Green ID Color
Band Ring**



850 0004-319

**Yellow ID Color
Band Ring**



850 0004-320

**Blue ID Color
Band Ring**



850 0004-321

**Orange ID Color
Band Ring**



850 0004-322

0.5mL Dose Chamber

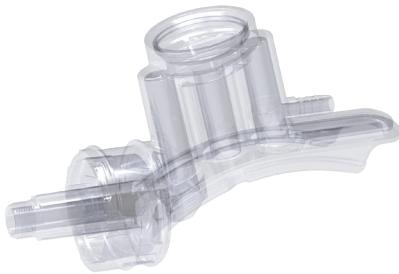

Includes: Dose Chamber (5); Spare O-rings (10);
15mL Lubricant Bottle

850 0004-490

1mL Dose Chamber

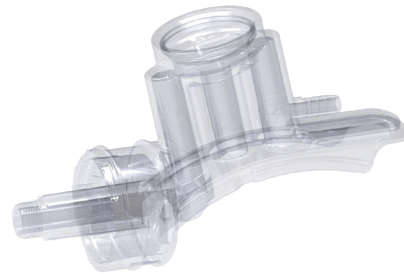

Includes: Dose Chamber (5); Spare O-rings (10);
15mL Lubricant Bottle

850 0004-491

2mL Dose Chamber

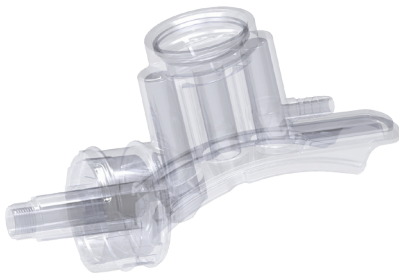

Includes: Dose Chamber (5); Spare O-rings (10);
15mL Lubricant Bottle

850 0004-492

5mL Dose Chamber

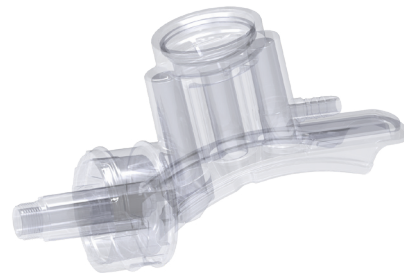

Includes: Dose Chamber (5); Spare O-rings (10);
15mL Lubricant Bottle

850 0004-493

VS INJECTOR ASSEMBLY

Bottle Mount Assembly

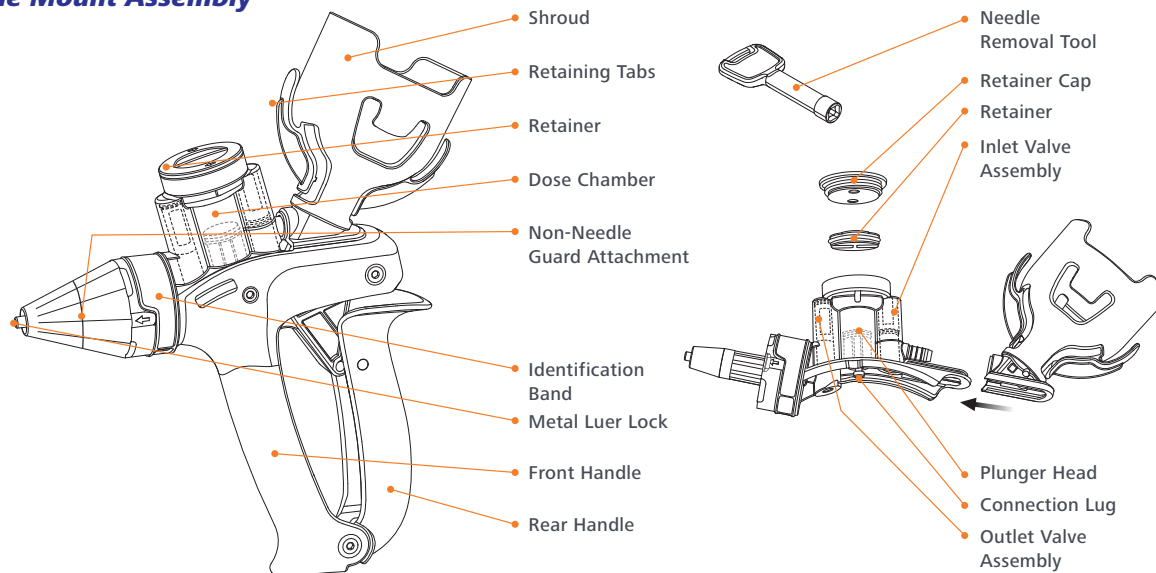

Tube Fed Assembly

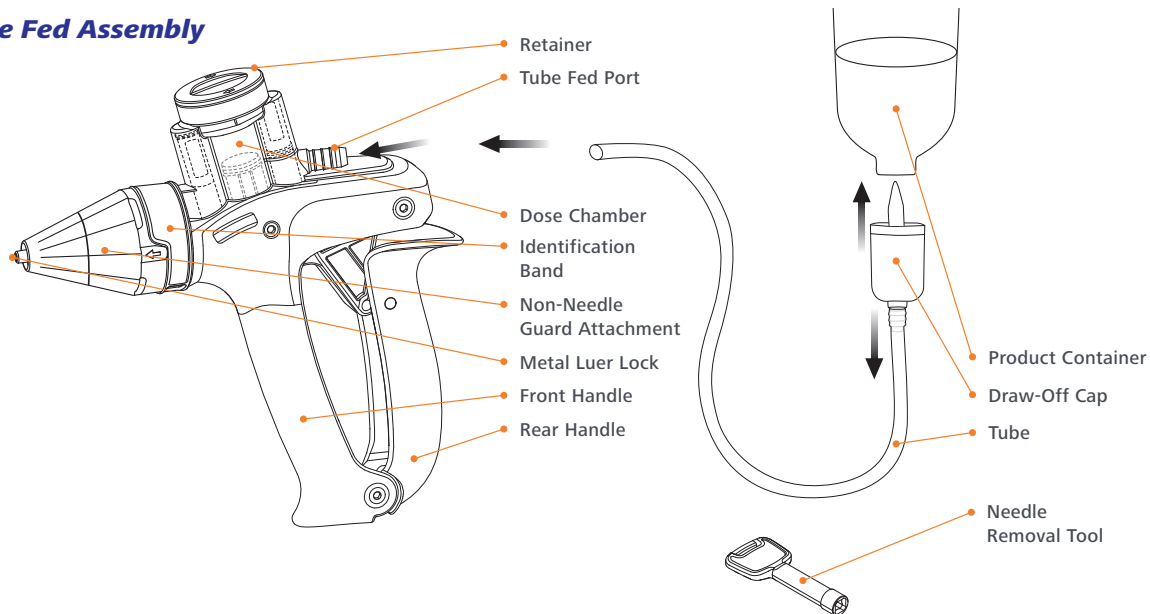

Dose Conversion Kits Assembly

1. Remove the Needle Guard Assembly by locking it and pulling the locking ring forward, keeping the handset locked.
2. Slide the Dose Chamber down and forward to detach it from the Handset.
3. Unscrew the Retainer Cap.
4. Use the Needle Guard assembly to unlock the assembly and compress the Needle Guard into the housing to expose two prongs. With one of these prongs, push upwards on the Plunger Head (from the underside) to remove the Retainer
5. Choose the appropriate Plunger Head, lubricate the o-ring, insert it into the Dose Chamber, and secure it with the Retainer Cap.
6. Slide the Dose Chamber back onto the handset, ensuring correct alignment with the Plunger Push Rod.
7. Replace the Needle Guard assembly by locking it and pushing it back into the Dose Chamber.

NOTE: Remove plungers from family tree by rotating them for the connection break; cutting not necessary. Remember to lubricate o-rings before use. Use black inlet and outlet valve assemblies for low dose applications.

VS Injector

Dose Conversion Kits

njphillips
DATAMARS

Simcro
DATAMARS

Versatility & Accuracy in One Powerful Tool

NJ Phillips & Simcro Dose Conversion Kits are explicitly designed for the VS Injector, offering additional dose configurations for a variety of vaccines and animal treatments. When paired with the versatile VS Injector, these kits enable the administration of precise subcutaneous and intramuscular ensuring accurate dosage and efficient delivery. This not only promotes optimum animal welfare but also enhances operator safety. For assembly instructions, see page 16.

0.5mL Dose Conversion Kit



Dose Range: 0.1mL – 0.5mL

Dose Increments: 0.05mL

Includes: 9 Dose Conversion Assemblies; O-rings; 15mL Lubricant

850 0004-874 NJP

850 0004-638 SIM

1mL Dose Conversion Kit



Dose Range: 0.5mL – 1mL

Dose Increments: 0.05mL

Includes: 11 Dose Conversion Assemblies; O-rings; 15mL Lubricant

850 0004-875 NJP

850 0004-639 SIM

2mL Dose Conversion Kit



Dose Range: 1mL – 2mL

Dose Increments: 0.1mL

Includes: 11 Dose Conversion Assemblies; O-rings; 15mL Lubricant

850 0004-876 NJP

850 0004-640 SIM

5mL Dose Conversion Kit



Dose Range: 2mL – 5mL

Dose Increments: 0.5mL

Includes: 7 Dose Conversion Assemblies; O-rings; 15mL Lubricant

850 0004-877 NJP

850 0004-641 SIM

Metal & Pistol Grip Repeater Syringes

njphillips
DATAMARS

Metal Repeater Syringes

NJ Phillips 25mL / 50mL Metal Repeater Injector features an ergonomic handle designed for the mass administration of various vaccines. This injector is easy-to-clean and maintain, with fixed settings that ensure convenience and efficiency. The dosages are in 0.5mL graduations and the injector fills through the tip.

Pistol Grip Repeater Syringes

NJ Phillips 25mL / 50mL Pistol Grip Repeater Injector offers 5 fixed-dose settings for cost-effective, reliable, and durable use. With a built-in needle magazine for time efficiency and ergonomic fingertip action, it doses in 1.0mL graduations. Injectors fill through the tip and saves time when changing out needles. Additionally, this product is available with a Polypropylene Barrel option for increased chemical resistance.

For assembly instructions of Metal and Pistol Grip Repeaters, see page 21.

Features & Benefits:



ERGONOMIC
DESIGN



EASY TO
CLEAN



EFFICIENCY



VARIETY OF
VACCINES

REPEATER SYRINGES

25mL / 50mL Metal Polysulfone Barrel Repeater Syringe

- Ergonomic Handle
- Accuracy
- Administers Multiple Vaccines
- Robust Durability
- Fixed Dose Settings
- Service Kit Available

25mL Dose Range: 0.5mL – 25mL
 25mL Dose Increments: 0.5mL
 50mL Dose Range: 1mL – 50mL
 50mL Dose Increments: 1mL
 Includes: O-ring



25mL 850 0000-042
 50mL 850 0000-043

25mL / 50mL Pistol Grip Polysulfone Barrel Repeater Syringe

- Ergonomic Finger Tip Action
- Accuracy
- Administers Multiple Vaccines
- Robust Durability
- Fixed Dose Settings
- Service Kit Available

25mL Dose Range: 0.5mL – 25mL
 25mL Dose Increments: 0.5mL
 50mL Dose Range: 1mL – 50mL
 50mL Dose Increments: 1mL
 Includes: Wrench



25mL 850 0000-040
 50mL 850 0000-041

25mL / 50mL Pistol Grip Polypropylene Barrel Repeater Syringe

- Polypropylene barrel for increased chemical resistance
- Ergonomic Finger Tip Action
- Accuracy
- Administers Multiple Vaccines
- Robust Durability
- Fixed Dose Settings
- Service Kit Available

25mL Dose Range: 0.5mL – 25mL
 25mL Dose Increments: 0.5mL
 50mL Dose Range: 1mL – 50mL
 50mL Dose Increments: 1mL
 Includes: Wrench



25mL 850 0000-044
 50mL 850 0000-045

REPEATER ACCESSORIES

25mL Polysulfone Barrel Repeater Major Kit

- Barrel fits metal & plastic repeaters



Dose Range: 0.5mL – 25mL
 Dose Increments: 0.5mL
 Includes: (1) Polysulfone Barrel; (1) O-ring

850 0000-058

25mL Polypropylene Barrel Repeater Major Kit

- Barrel fits metal & plastic repeaters



Dose Range: 0.5mL – 25mL
 Dose Increments: 0.5mL
 Includes: (1) Polypropylene Barrel; (1) O-ring; (1) Wrench

850 0000-232

50mL Polysulfone Barrel Repeater Major Kit

- Barrel fits metal & plastic repeaters

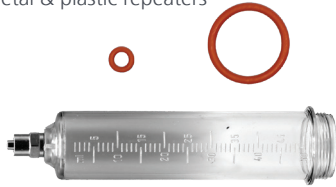

Dose Range: 1mL – 50mL
 Dose Increments: 1mL
 Includes: (1) Polysulfone Barrel; (1) Large O-ring; (1) Small O-ring

850 0000-054

50mL Polypropylene Barrel Repeater Major Kit

- Barrel fits metal & plastic repeaters



Dose Range: 1mL – 50mL
 Dose Increments: 1mL
 Includes: (1) Polypropylene Barrel; (1) O-ring; (1) Wrench

850 0000-057

Color Repeater Knobs



850 0000-000 4/PK

Black Repeater Knob

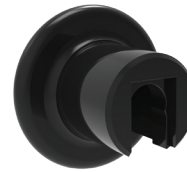

850 0000-266

25mL / 50mL Repeater O-Rings (5pk)

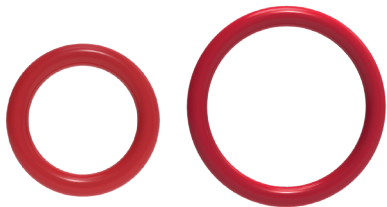

25mL 850 0000-140 5PK
 50mL 850 0000-143 5PK

Trigger Pawl for Metal Repeaters



850 0000-149

25mL Dose Adjuster Assembly
Metal Repeater



850 0000-133

50mL Dose Adjuster Assembly
Metal Repeater



850 0000-132

25mL Push Rod & Piston
Metal & Plastic Repeater

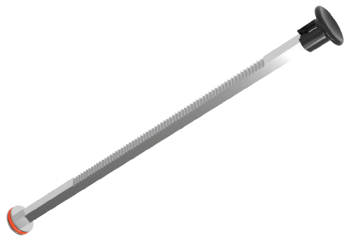

850 0000-246

50mL Push Rod & Piston
Metal & Plastic Repeater

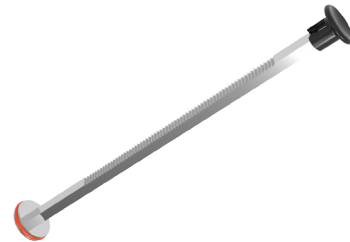

850 0000-244

REPEATER ASSEMBLY

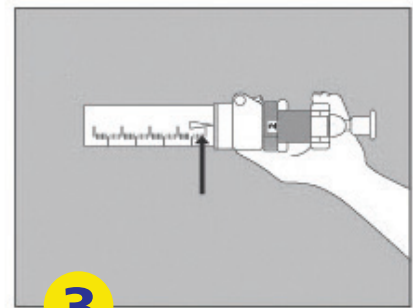
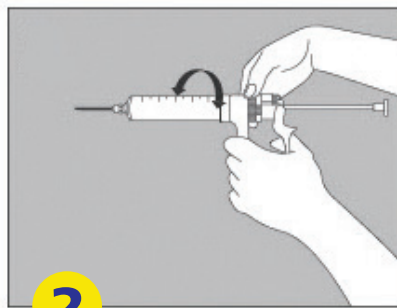
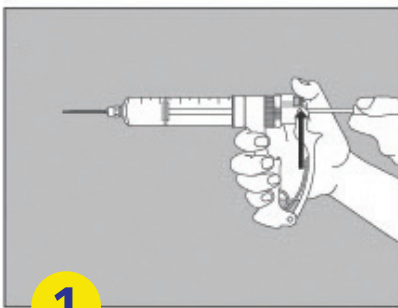

To set the dose, first, press the button on top of the device, ensuring that the spring underneath is fully compressed. Then, pull the barrel plunger to the back of the barrel (1). Next, turn the dose selector either clockwise or counterclockwise (2) until the desired dose aligns with the arrow at the top of the device (3).

Nylon Syringes

njphillips
DATAMARS

Simcro
DATAMARS

Nylon syringes are designed for one-hand operation and are easy to disassemble. Our nylon syringes fill through the tip and have an ergonomic handle. The dose can be easily set using the dosing lock, conveniently located just above the barrel. These injectors are reusable and easy to clean, making them an essential tool for any operation. See page 11 for assembly instructions.

10mL Nylon Selectable Syringe



Dose Range: 1mL – 10mL
Dose Increments: 1mL
Includes: Large & Small Plunger O-rings; Metal Luer Lock

850 0005-066

20mL Nylon Selectable Syringe



Dose Range: 1mL – 20mL
Dose Increments: 1mL
Includes: Large & Small Plunger O-rings; Metal Luer Lock

850 0005-067

30mL Nylon Selectable Syringe



Dose Range: 1mL – 30mL
Dose Increments: 1mL
Includes: Large & Small Plunger O-rings; Metal Luer Lock

850 0005-068

50mL Nylon Selectable Syringe



Dose Range: 5mL – 50mL
Dose Increments: 5mL
Includes: Large & Small Plunger O-rings; Metal Luer Lock

850 0005-069

ACCESSORIES

Drench Nozzle



Includes: Large & Small Plunger O-rings; Metal Luer Lock

850 0005-070

Backpack Solutions

njphillips
DATAMARS

Simcro
DATAMARS

Large-volume Vaccination Solutions

Our selection of large-volume vaccination products ensures easy transport and convenience. These items can be seamlessly integrated with our animal health devices to create a comprehensive delivery solution.

2.5L Backpack with Storage Pocket



- Ergonomic Handle
- Can Sit Upright on a Flat Surface
- Pocket Storage for Straps & Caps
- Tamper Evident

Includes: 38mm Dual Vented Cap; Cone Cap; Strap

850 0000-068

5L Backpack with Storage Pocket



- Ergonomic Handle
- Can Sit Upright on a Flat Surface
- Pocket Storage for Straps & Caps
- Tamper Evident

Includes: 38mm Dual Vented Cap; Cone Cap; Strap

850 0000-069

ACCESSORIES

38mm Vented Spigot Cap



850 0000-073

38mm Upright Cap



850 0000-074

Pour-on & Oral Drenchers

njphillips
DATAMARS

Simcro
DATAMARS

Our Pour-on and Oral Drencher product line is designed with ergonomic aesthetics to minimize hand strain during extended use. These options come with selectable and variable dose control settings, catering to various dose ranges suitable for swine, goats, cattle, and horses.

Specifically tailored for administering a wide range of oral anthelmintics, our Oral Drenchers prioritize operator comfort, ease of administration, accuracy, and durability. Years of refinement have yielded a comprehensive range of oral options, featuring tube fed connections and non-drip nozzles for added convenience. Furthermore, the Oral Drencher design is reliable and robust, making it suitable for use in demanding environments.

Our Pour-on applicators boast a smooth-action V-grip handle, selectable 'dial-a-dose' adjustment, and an angled nozzle with an in-built diffuser. The angle nozzle can be rotated and locked at the desired angle, while the diffuser helps minimize run-off during higher application rates. Additionally, the dose adjustment system is user-friendly.

Features & Benefits:



ERGONOMIC
DESIGN



MAXIMIZE
EFFICIENCY



ACCURACY



DURABLE
CONSTRUCTION



VARIETY OF
VACCINES

ACCESSORIES

20mL Metal Oral Drencher Major Kit



Includes: Cylinder (Barrel); (5) O-rings; Values & Springs;
Return Spring; Piston; Level Pad; CirClip; Lubricant Bottle;
Lubricating Washer; Pushrod Guide

850 0000-138

POUR-ONS & ORAL DRENCHERS

12.5mL Bottle Mount Multi-doser Oral Drencher Applicator



Suitable for 500mL & 750mL Bottles
Dose Range: 1mL – 12.5mL
Dose Increments: 1mL
Includes: 125mL Bottle Shroud

850 0000-114

15mL Variable Tube Fed Pour-on & Oral Drencher Applicator



Dose Range: 1mL – 15mL
Dose Increments: 1mL
Includes: Tube; 1/4" Drench Oral Nozzle

850 0000-049

15mL Reverse Selectable The Ranch Pack Applicator



Dose Range: 1mL – 15mL
Dose Increments: 0.5mL
Includes: 15mL Optimiser™ Injector; 15mL barrel; Metal Drench Nozzle; Plastic Pour-on Nozzle; Tube; 20mm, 27mm, 33mm Draw-off Caps; (4) 16G 1/2" Needles

850 0000-010

20mL Metal Variable Pour-on & Oral Drencher Applicator



Dose Range: 1mL – 20mL
Dose Increments: 1mL
Includes: 4" Sheep Nozzle; 6" Cattle Nozzle

850 0000-011
850 0000-138 SERVICE KIT

30mL Variable Tube Fed Oral Drencher Applicator



Dose Range: 1mL – 30mL
Dose Increments: 0.5mL
Includes: 450mm Cattle Nozzle; Tube

850 0000-036

60mL Variable Tube Fed Pour-on Applicator



Dose Range: 5mL – 60mL
Dose Increments: 5mL
Includes: Tube; Pour-on Nozzle

850 0000-050

65mL Tube Fed Pour-on Applicator



Dose Range: 2.5mL – 65mL
Dose Increments: 2.5mL
Includes: Tube; Fan Nozzle

850 0000-120

70mL Magnum Selectable Tube Fed Pour-on Applicator



Dose Range: 10mL – 70mL
Dose Increments: 2.5mL
Includes: Tube

850 0000-047



Disposable Needles & Syringes

Quality Products, Exceptional Service & Support – One Stop Shop for Animal Health Solutions

NJ Phillips brand of syringes is a suite of animal health management solutions including needles, syringes and combos. A clear polypropylene barrel with large easy-to-read graduations support accuracy when administering vaccines and treatments. The ultra-sharp needles are color coded for easy identification. Quality disposable needle and syringe product line compliments our Animal Health Delivery Systems (AHDS) products. See page 35 for how to choose the correct needle or syringe.

	<p>POLYPROPYLENE HUB</p> <ul style="list-style-type: none"> • Single Injections • Small Animal & Equine
	<p>ALUMINIUM HUB</p> <ul style="list-style-type: none"> • Durable • Multi-use
	<p>NEEDLE COMBOS</p> <ul style="list-style-type: none"> • Ultra-sharp Needle with Syringe • Luer Lock or Luer Slip Options
	<p>LUER SLIP SYRINGES</p> <ul style="list-style-type: none"> • Quick to change, push on friction-fit connection • Polypropylene Syringe • Recommended for Healthy Livestock Treatments
	<p>LUER LOCK SYRINGES</p> <ul style="list-style-type: none"> • Secure connection by threading for a “locking” fit onto the syringe • Polypropylene Syringe • Recommended for Sick Livestock Treatments
	<p>CATHETER SYRINGES</p> <ul style="list-style-type: none"> • Polypropylene Feeding or Irrigation Syringe • Used for flushing/cleaning catheters, tubes, etc.

QUICK GUIDE

16G

18G

20G

22G

Ea = Each
Pk = Pack

Ct = Carton
Cs = Case

SPECIFICATIONS

ALUMINUM HUB NEEDLES

Alum Hub	SKU	UPC	Weight	Quantity	Dimensions
16G Aluminum Hub 3/4" Needle (5Pk)	850 0005-004	846353012938 Pk 846353015236 Ct	17G Pk 3KG Ct 12KG Cs	5 Ea per Pk 150 Pks per Ct 4 Cts per Cs	4.75" x 4" x .4" Pk 11" x 8.7" x 7.9" Ct 18.3" x 11.8" x 16.7" Cs
16G Aluminum Hub 1" Needle (5Pk)	850 0005-005	846353012945 Pk 846353015212 Ct	17G Pk 3KG Ct 12KG Cs	5 Ea per Pk 150 Pks per Ct 4 Cts per Cs	4.75" x 4" x .4" Pk 11" x 8.7" x 7.9" Ct 18.3" x 11.8" x 16.7" Cs
16G Aluminum Hub 1 1/2" Needle (5Pk)	850 0005-006	846353012952 Pk 846353015199 Ct	17G Pk 3KG Ct 12KG Cs	5 Ea per Pk 150 Pks per Ct 4 Cts per Cs	4.75" x 4" x .4" Pk 11" x 8.7" x 7.9" Ct 18.3" x 11.8" x 16.7" Cs
18G Aluminum Hub 3/4" Needle (5Pk)	850 0005-008	846353012976 Pk 846353015182 Ct	17G Pk 3KG Ct 12KG Cs	5 Ea per Pk 150 Pks per Ct 4 Cts per Cs	4.75" x 4" x .4" Pk 11" x 8.7" x 7.9" Ct 18.3" x 11.8" x 16.7" Cs
18G Aluminum Hub 1" Needle (5Pk)	850 0005-009	846353012983 Pk 846353015175 Ct	17G Pk 3KG Ct 12KG Cs	5 Ea per Pk 150 Pks per Ct 4 Cts per Cs	4.75" x 4" x .4" Pk 11" x 8.7" x 7.9" Ct 18.3" x 11.8" x 16.7" Cs
20G Aluminum Hub 1" Needle (5Pk)	850 0005-011	846353013003 Pk 846353015427 Ct	17G Pk 3KG Ct 12KG Cs	5 Ea per Pk 150 Pks per Ct 4 Cts per Cs	4.75" x 4" x .4" Pk 11" x 8.7" x 7.9" Ct 18.3" x 11.8" x 16.7" Cs

Alum Hub	SKU	UPC	Weight	Quantity	Dimensions
16G Aluminum Hub 1" Needle (25Pk)	850 0005-035	846353013249 Pk 846353015229 Ct	62G Pk 3.63KG Ct 14.5KG Cs	25 Ea per Pk 50 Pks per Ct 4 Cts per Cs	6" x 4" x 1.4" Pk 11" x 8.7" x 7.9" Ct 18.3" x 11.8" x 16.7" Cs
16G Aluminum Hub 1 1/2" Needle (25Pk)	850 0005-036	846353013256 Pk 846353015205 Ct	74G Pk 3.63KG Ct 14.5KG Cs	25 Ea per Pk 50 Pks per Ct 4 Cts per Cs	6" x 4" x 1.4" Pk 11" x 8.7" x 7.9" Ct 18.3" x 11.8" x 16.7" Cs

POLYPROPYLENE HUB NEEDLES

Poly Hub	SKU	UPC	Weight	Quantity	Dimensions
16G Poly Hub 1/2" Needle (5Pk)	850 0005-014	846353013034 Pk 846353015380 Ct	13G Pk 1.25KG Ct 5KG Cs	5 Ea per Pk 150 Pks per Ct 4 Cts per Cs	4.75" x 4" x .4" Pk 11" x 8.7" x 7.9" Ct 18.3" x 11.8" x 16.7" Cs
16G Poly Hub 1" Needle (5Pk)	850 0005-015	846353013041 Pk 846353015397 Ct	13G Pk 1.25KG Ct 5KG Cs	5 Ea per Pk 150 Pks per Ct 4 Cts per Cs	4.75" x 4" x .4" Pk 11" x 8.7" x 7.9" Ct 18.3" x 11.8" x 16.7" Cs
16G Poly Hub 1 1/2" Needle (5Pk)	850 0005-016	846353013058 Pk 846353015410 Ct	13G Pk 1.25KG Ct 5KG Cs	5 Ea per Pk 150 Pks per Ct 4 Cts per Cs	4.75" x 4" x .4" Pk 11" x 8.7" x 7.9" Ct 18.3" x 11.8" x 16.7" Cs
18G Poly Hub 3/4" Needle (5Pk)	850 0005-017	846353013065 Pk 846353015335 Ct	13G Pk 1.25KG Ct 5KG Cs	5 Ea per Pk 150 Pks per Ct 4 Cts per Cs	4.75" x 4" x .4" Pk 11" x 8.7" x 7.9" Ct 18.3" x 11.8" x 16.7" Cs
18G Poly Hub 1" Needle (5Pk)	850 0005-018	846353013072 Pk 846353015342 Ct	13G Pk 1.25KG Ct 5KG Cs	5 Ea per Pk 150 Pks per Ct 4 Cts per Cs	4.75" x 4" x .4" Pk 11" x 8.7" x 7.9" Ct 18.3" x 11.8" x 16.7" Cs

SPECIFICATIONS

POLYPROPYLENE HUB NEEDLES

Poly Hub	SKU	UPC	Weight	Quantity	Dimensions
18G Poly Hub 1 1/2" Needle (5Pk)	850 0005-019	846353013089 Pk 846353015366 Ct	13G Pk 1.25KG Ct 5KG Cs	5 Ea per Pk 150 Pks per Ct 4 Cts per Cs	4.75" x 4" x .4" Pk 11" x 8.7" x 7.9" Ct 18.3" x 11.8" x 16.7" Cs
20G Poly Hub 1/2" Needle (5Pk)	850 0005-022	846353013119 Pk 846353015274 Ct	13G Pk 1.25KG Ct 5KG Cs	5 Ea per Pk 150 Pks per Ct 4 Cts per Cs	4.75" x 4" x .4" Pk 11" x 8.7" x 7.9" Ct 18.3" x 11.8" x 16.7" Cs
20G Poly Hub 3/4" Needle (5Pk)	850 0005-023	846353013126 Pk 846353015298 Ct	13G Pk 1.25KG Ct 5KG Cs	5 Ea per Pk 150 Pks per Ct 4 Cts per Cs	4.75" x 4" x .4" Pk 11" x 8.7" x 7.9" Ct 18.3" x 11.8" x 16.7" Cs
20G Poly Hub 1" Needle (5Pk)	850 0005-024	846353013133 Pk 846353015311 Ct	13G Pk 1.25KG Ct 5KG Cs	5 Ea per Pk 150 Pks per Ct 4 Cts per Cs	4.75" x 4" x .4" Pk 11" x 8.7" x 7.9" Ct 18.3" x 11.8" x 16.7" Cs
20G Poly Hub 1 1/2" Needle (5Pk)	850 0005-025	846353013140 Pk 846353015328 Ct	13G Pk 1.25KG Ct 5KG Cs	5 Ea per Pk 150 Pks per Ct 4 Cts per Cs	4.75" x 4" x .4" Pk 11" x 8.7" x 7.9" Ct 18.3" x 11.8" x 16.7" Cs
22G Poly Hub 3/4" Needle (5Pk)	850 0005-027	846353013164 Pk 846353015236 Ct	13G Pk 1.25KG Ct 5KG Cs	5 Ea per Pk 150 Pks per Ct 4 Cts per Cs	4.75" x 4" x .4" Pk 11" x 8.7" x 7.9" Ct 18.3" x 11.8" x 16.7" Cs
22G Poly Hub 1" Needle (5Pk)	850 0005-028	846353013171 Pk 846353015250 Ct	13G Pk 1.25KG Ct 5KG Cs	5 Ea per Pk 150 Pks per Ct 4 Cts per Cs	4.75" x 4" x .4" Pk 11" x 8.7" x 7.9" Ct 18.3" x 11.8" x 16.7" Cs

Bulk Poly Hub	SKU	UPC	Weight	Quantity	Dimensions
16G Poly Hub 1" Needle (25Pk)	850 0005-045	846353013348 Pk 846353015403 Ct	46G Pk 2KG Ct 8KG Cs	25 Ea per Pk 50 Pks per Ct 4 Cts per Cs	6" x 4" x 1" Pk 11" x 8.7" x 7.9" Ct 18.3" x 11.8" x 16.7" Cs
18G Poly Hub 1" Needle (25Pk)	850 0005-048	846353013379 Pk 846353015359 Ct	46G Pk 2KG Ct 8KG Cs	25 Ea per Pk 50 Pks per Ct 4 Cts per Cs	6" x 4" x 1" Pk 11" x 8.7" x 7.9" Ct 18.3" x 11.8" x 16.7" Cs
18G Poly Hub 1 1/2" Needle (25Pk)	850 0005-049	846353013386 Pk 846353015373 Ct	48G Pk 2KG Ct 8KG Cs	25 Ea per Pk 50 Pks per Ct 4 Cts per Cs	6" x 4" x 1" Pk 11" x 8.7" x 7.9" Ct 18.3" x 11.8" x 16.7" Cs
20G Poly Hub 1/2" Needle (25Pk)	850 0005-052	846353013416 Pk 846353015281 Ct	41G Pk 2KG Ct 8KG Cs	25 Ea per Pk 50 Pks per Ct 4 Cts per Cs	6" x 4" x 1" Pk 11" x 8.7" x 7.9" Ct 18.3" x 11.8" x 16.7" Cs
20G Poly Hub 3/4" Needle (25Pk)	850 0005-053	846353013423 Pk 846353015304 Ct	42G Pk 2KG Ct 8KG Cs	25 Ea per Pk 50 Pks per Ct 4 Cts per Cs	6" x 4" x 1" Pk 11" x 8.7" x 7.9" Ct 18.3" x 11.8" x 16.7" Cs
22G Poly Hub 3/4" Needle (25Pk)	850 0005-057	846353013461 Pk 846353015243 Ct	41G Pk 2KG Ct 8KG Cs	25 Ea per Pk 50 Pks per Ct 4 Cts per Cs	6" x 4" x 1" Pk 11" x 8.7" x 7.9" Ct 18.3" x 11.8" x 16.7" Cs
22G Poly Hub 1" Needle (25Pk)	850 0005-058	846353013478 Pk 846353015267 Ct	42G Pk 2KG Ct 8KG Cs	25 Ea per Pk 50 Pks per Ct 4 Cts per Cs	6" x 4" x 1" Pk 11" x 8.7" x 7.9" Ct 18.3" x 11.8" x 16.7" Cs

LUER LOCK SYRINGES

Luer Lock Syringe	SKU	UPC	Weight	Quantity	Dimensions
3CC Luer Lock Syringe (6Pk)	850 0005-075	846353014543 Ea/Pk 846353015670 Ct	34G Pk 3.25KG Ct 13KG Cs	70 Pks per Ct 4 Cts per Cs	4.5" x 8.5" x 1.5" Pk 17.7" x 11.6" x 10.8" Ct 24" x 18.5" x 22.8" Cs
6CC Luer Lock Syringe (6Pk)	850 0005-076	846353014550 Ea/Pk 846353015687 Ct	47G Pk 4KG Ct 16KG Cs	72 Pks per Ct 4 Cts per Cs	4.5" x 9" x 1.8" Pk 17.7" x 11.6" x 10.8" Ct 24" x 18.5" x 22.8" Cs
12CC Luer Lock Syringe (4Pk)	850 0005-077	846353014567 Ea/Pk 846353015694 Ct	50G Pk 3.75KG Ct 15KG Cs	60 Pks per Ct 4 Cts per Cs	4.5" x 9" x 1.8" Pk 17.7" x 11.6" x 10.8" Ct 24" x 18.5" x 22.8" Cs
20CC Luer Lock Syringe (4Pk)	850 0005-078	846353014574 Ea/Pk 846353015700 Ct	67G Pk 3.75KG Ct 15KG Cs	40 Pks per Ct 4 Cts per Cs	4.5" x 9.5" x 2" Pk 17.7" x 11.6" x 10.8" Ct 24" x 18.5" x 22.8" Cs
35CC Luer Lock Syringe (2Pk)	850 0005-079	846353014581 Ea/Pk 846353015717 Ct	56G Pk 3.38KG Ct 13.5KG Cs	45 Pks per Ct 4 Cts per Cs	4.5" x 10.5" x 2.3" Pk 17.7" x 11.6" x 10.8" Ct 24" x 18.5" x 22.8" Cs
60CC Luer Lock Syringe (2Pk)	850 0005-080	846353014598 Ea/Pk 846353015724 Ct	81G Pk 4.13KG Ct 16.5KG Cs	40 Pks per Ct 4 Cts per Cs	4.5" x 11.5" x 2.3" Pk 17.7" x 11.6" x 10.8" Ct 24" x 18.5" x 22.8" Cs

LUER SLIP SYRINGES

Luer Slip Syringe	SKU	UPC	Weight	Quantity	Dimensions
3CC Luer Slip Syringe (6Pk)	850 0005-081	846353014604 Ea/Pk 846353015618 Ct	33G Pk 3.25KG Ct 13KG Cs	70 Pks per Ct 4 Cts per Cs	4.5" x 8.5" x 1.5" Pk 17.7" x 11.6" x 10.8" Ct 24" x 18.5" x 22.8" Cs
6CC Luer Slip Syringe (6Pk)	850 0005-082	846353014611 Ea/Pk 846353015625 Ct	45G Pk 4KG Ct 16KG Cs	72 Pks per Ct 4 Cts per Cs	4.5" x 9" x 1.8" Pk 17.7" x 11.6" x 10.8" Ct 24" x 18.5" x 22.8" Cs
12CC Luer Slip Syringe (4Pk)	850 0005-083	846353014628 Ea/Pk 846353015632 Ct	49G Pk 3.75KG Ct 15KG Cs	60 Pks per Ct 4 Cts per Cs	4.5" x 9" x 1.8" Pk 17.7" x 11.6" x 10.8" Ct 24" x 18.5" x 22.8" Cs
20CC Luer Slip Syringe (4Pk)	850 0005-084	846353014635 Ea/Pk 846353015649 Ct	67G Pk 3.75KG Ct 15KG Cs	40 Pks per Ct 4 Cts per Cs	4.5" x 10" x 2" Pk 17.7" x 11.6" x 10.8" Ct 24" x 18.5" x 22.8" Cs
35CC Luer Slip Syringe (2Pk)	850 0005-085	846353014642 Ea/Pk 846353015656 Ct	56G Pk 3.38KG Ct 13.5KG Cs	45 Pks per Ct 4 Cts per Cs	4.5" x 10.5" x 2.3" Pk 17.7" x 11.6" x 10.8" Ct 24" x 18.5" x 22.8" Cs
60CC Luer Slip Syringe (2Pk)	850 0005-086	846353014659 Ea/Pk 846353015663 Ct	82G Pk 4.13KG Ct 16.5KG Cs	40 Pks per Ct 4 Cts per Cs	4.5" x 11.5" x 2.3" Pk 17.7" x 11.6" x 10.8" Ct 24" x 18.5" x 22.8" Cs

QUICK GUIDE

16G**18G****20G****22G**Ea = Each
Pk = PackCt = Carton
Cs = Case

SPECIFICATIONS

BULK LUER LOCK SYRINGES

Bulk Luer Lock	SKU	UPC	Weight	Quantity	Dimensions
3CC Luer Lock Syringe (100Pk)	850 0005-098	846353014956 Ea 846353014857 Ct 846353015557 Cs	.67KG Ct 16KG Cs	100 Pk per Ct 24 Cts per Cs	8.5" x 5.3" x 5.1" Ct 22" x 17.7" x 16.3" Cs
6CC Luer Lock Syringe (100Pk)	850 0005-099	846353014963 Ea 846353014864 Ct 846353015564 Cs	.83KG Ct 20KG Cs	100 Pk per Ct 24 Cts per Cs	9.3" x 5.5" x 6.9" Ct 22.8" x 19.3" x 21.7" Cs
12CC Luer Lock Syringe (100Pk)	850 0005-100	846353014970 Ea 846353014871 Ct 846353015571 Cs	.63KG Ct 15KG Cs	100 Pk per Ct 24 Cts per Cs	8.7" x 6.3" x 9.4" Ct 22.8" x 19.3" x 21.7" Cs
20CC Luer Lock Syringe (50Pk)	850 0005-101	846353014987 Ea 846353014888 Ct 846353015588 Cs	1KG Ct 18KG Cs	50 Pk per Ct 18 Cts per Cs	9.8" x 6.3" x 6.7" Ct 20.5" x 19.7" x 21.1" Cs
35CC Luer Lock Syringe (50Pk)	850 0005-102	846353014994 Ea 846353014895 Ct 846353015595 Cs	1.13KG Ct 18KG Cs	50 Pk per Ct 16 Cts per Cs	10.6" x 7.6" x 7.9" Ct 23.2" x 11.2" x 18.7" Cs
60CC Luer Lock Syringe (25Pk)	850 0005-103	846353015007 Ea 846353014901 Ct 846353015601 Cs	.88KG Ct 7KG Cs	25 Pk per Ct 8 Cts per Cs	8.7" x 9.1" x 6.3" Ct 20.1" x 13.4" x 19.1" Cs

NEEDLE COMBOS

Luer Lock Combo	SKU	UPC	Weight	Quantity	Dimensions
3CC Luer Lock Syringe 22G 3/4" Needle (3Pk)	850 0005-071	846353014505 Ea/Pk 846353015519 Ct	24G Ea 3.25KG Ct 13KG Cs	3 Ea per Pk 100 Pks per Ct 4 Cts per Cs	10.5" x 4.5" x .9" Pk 17.7" x 11.6" x 10.8" Ct 24" x 18.5" x 22.8" Cs
3CC Luer Lock Syringe 22G 1" Needle (3Pk)	850 0005-072	846353014512 Ea/Pk 846353015526 Ct	24G Ea 3.25KG Ct 13KG Cs	3 Ea per Pk 100 Pks per Ct 4 Cts per Cs	10.5" x 4.5" x .9" Pk 17.7" x 11.6" x 10.8" Ct 24" x 18.5" x 22.8" Cs
12CC Luer Lock Syringe 18G 1" Needle (3Pk)	850 0005-073	846353014529 Ea/Pk 846353015540 Ct	44G Ea 3.5KG Ct 14KG Cs	3 Ea per Pk 100 Pks per Ct 4 Cts per Cs	11" x 4.5" x 1.5" Pk 17.7" x 11.6" x 10.8" Ct 24" x 18.5" x 22.8" Cs
12CC Luer Lock Syringe 20G 1" Needle (3Pk)	850 0005-074	846353015526 Ea/Pk 846353015533 Ct	43G Ea 3.5KG Ct 14KG Cs	3 Ea per Pk 100 Pks per Ct 4 Cts per Cs	11" x 4.5" x 1.5" Pk 17.7" x 11.6" x 10.8" Ct 24" x 18.5" x 22.8" Cs

CATHETER TIPS

Catheter Tip	SKU	UPC	Weight	Quantity	Dimensions
60CC Catheter Tip Syringe (25Pk)	850 0005-093	846353015106 Ea 846353014727 Ct 846353015731 Cs	10KG Ct 60KG Cs	25 Pks per Ct 6 Cts per Cs	9.6" x 9.1" x 6.3" Ct 20.1" x 9.8" x 20.3" Cs

BULK NEEDLE COMBOS

Bulk Luer Lock Combo	SKU	UPC	Weight	Quantity	Dimensions
3CC Luer Lock Syringe 22G 3/4" Needle (100Pk)	850 0005-104	846353015151 Ea 846353014918 Ct 846353015472 Cs	.75KG Ct 18KG Cs	100 Pk per Ct 24 Cts per Cs	8.5" x 7.5" x 5.1" Ct 23.2" x 17.7" x 21.5" Cs
3CC Luer Lock Syringe 22G 1" Needle (100Pk)	850 0005-105	846353015014 Ea 846353014925 Ct 846353015489 Cs	.75KG Ct 18KG Cs	100 Pk per Ct 24 Cts per Cs	8.5" x 7.5" x 5.1" Ct 23.2" x 17.7" x 21.5" Cs
12CC Luer Lock Syringe 18G 1" Needle (100Pk)	850 0005-107	846353015038 Ea 846353014949 Ct 846353015502 Cs	1.5KG Ct 18KG Cs	100 Pk per Ct 12 Cts per Cs	8.7" x 8.5" x 9.1 Ct 26.2" x 18.1" x 19.1 Cs
12CC Luer Lock Syringe 20G 1" Needle (100Pk)	850 0005-106	846353015021 Ea 846353014932 Ct 846353015496 Cs	1.5KG Ct 18KG Cs	100 Pk per Ct 12 Cts per Cs	8.7" x 8.5" x 9.1 Ct 26.2" x 18.1" x 19.1 Cs

Bulk Luer Slip Combo	SKU	UPC	Weight	Quantity	Dimensions
3CC Luer Slip Syringe 22G 3/4" Needle (100Pk)	850 0005-094	846353015113 Ea 846353014734 Ct 846353015434 Cs	.75KG Ct 18KG Cs	100 Pk per Ct 24 Cts per Cs	8.5" x 7.5" x 5.1" Ct 23.2" x 17.7" x 21.5" Cs
3CC Luer Slip Syringe 22G 1" Needle (100Pk)	850 0005-095	846353015120 Ea 846353014741 Ct 846353015441 Cs	.75KG Ct 18KG Cs	100 Pk per Ct 24 Cts per Cs	8.5" x 7.5" x 5.1" Ct 23.2" x 17.7" x 21.5" Cs
12CC Luer Slip Syringe 18G 1" Needle (100Pk)	850 0005-097	846353015144 Ea 846353014765 Ct 846353015465 Cs	.75KG Ct 18KG Cs	100 Pk per Ct 24 Cts per Cs	8.7" x 8.5" x 9.1 Ct 26.2" x 18.1" x 19.1 Cs
12CC Luer Slip Syringe 20G 1" Needle (100Pk)	850 0005-096	846353015137 Ea 846353014758 Ct 846353015458 Cs	.75KG Ct 18KG Cs	100 Pk per Ct 24 Cts per Cs	8.7" x 8.5" x 9.1 Ct 26.2" x 18.1" x 19.1 Cs

QUICK GUIDE

16G

18G

20G

22G

Ea = Each
Pk = PackCt = Carton
Cs = Case

Production Products

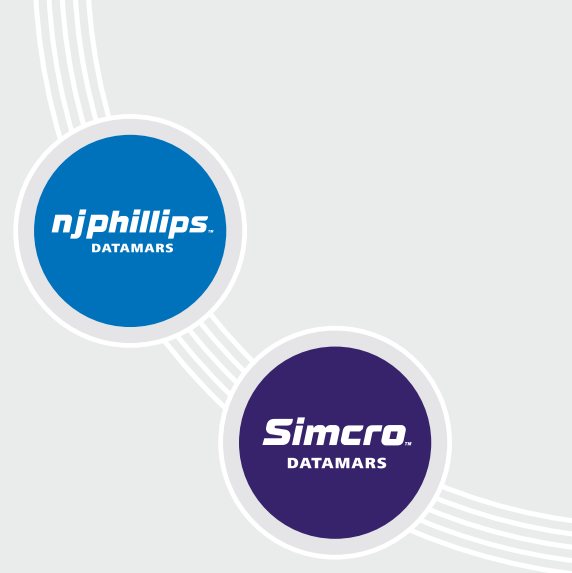

PowerMaster Series

The PowerMaster Series—a robust, user-friendly powered device designed for the administration of injectable, topical, and oral animal health vaccines. It ensures precise and consistent dosing at the beginning and end of each run. Engineered to meet the demands of high-productivity livestock operations, the PowerMaster Series guarantees durability and ease-of-use. For assembly instructions, see page 34.

- ✔ Powered by Compressed Air
- ✔ Ergonomic Handle for Relaxed Grip
- ✔ Accurate Dose Delivery
- ✔ Quick Refill Action
- ✔ Administers a Variety of Medications
- ✔ Easy Cleaning with Removable Barrel
- ✔ Repair & Service Kits Available

Sekurus™ Reverse Selectable Tube Fed Injector

The Sekurus™ range of safety injectors has undergone an extensive development process over several years, which involved thorough field trials conducted in various countries. Allows users to administer reliable, accurate, and safe single-handed subcutaneous injections. The patented two-stage mechanism is specifically crafted to ensure precise penetration and consistent dose placement with self-tenting technologies, whether in deep subcutaneous or intramuscular applications. For assembly instructions, see pages 10–11.

- ✔ Patented Self-tenting technologies
- ✔ Needle Guard reduces injuries
- ✔ Quick change for maximum efficiencies
- ✔ Safe operation in chutes
- ✔ Less invasive to the animal
- ✔ Accurate dosage in subcutaneous zone
- ✔ Reduces needle damage

VS Injector Bottle Mount & Tube Fed with Needle Guard

The VS Injector with Needle Guard is designed with ultimate flexibility for swine producers. For more information, see page 12 and assembly instructions on page 16.

- ✔ Ergonomic Design
- ✔ Versatility
- ✔ Compliance
- ✔ Sanitation & Food Safety
- ✔ Identification
- ✔ Animal Well-being

PRODUCTION PRODUCTS

15mL PowerMaster Pneumatic Air Tube Fed Injector



Dose Range: 1mL – 15mL
Dose Increments: 1mL
Includes: Injector; Tube (114mm X 1500mm)

850 0000-038
850 0000-233 SERVICE KIT

50mL PowerMaster Pneumatic Air Tube Fed Oral Drencher Applicator



Dose Range: 5mL – 50mL
Dose Increments: 2.5mL
Includes: Drencher; 11" Stainless Steel Hook Nozzle; Tube Feed Hose (114mm X 1500mm)

850 0000-037
850 0000-148 SERVICE KIT

65mL PowerMaster Pneumatic Air Tube Fed Pour-on Applicator



Dose Range: 5mL – 65mL
Dose Increments: 5mL
Includes: Pour-on; Tube (114mm X 1500mm)

850 0000-039
850 0000-139 SERVICE KIT

2mL Sekurus™ Reverse Selectable Tube Fed Injector



Patented Technology.
Dose Range: 0.5mL – 2mL
Dose Increments: 0.5mL
Includes: Small, Medium & Large Vented Draw-off Caps; Tube; 16G 3/4" Detectable Needle

850 0000-008

12mL Sekurus™ Reverse Selectable Tube Fed Injector



Patented Technology.
Dose Range: 2.5mL – 12mL
Dose Increments: 0.5mL
Includes: Small, Medium & Large Vented Draw-off Caps; Tube; 16G 1/2" Detectable Needle

850 0000-009

VS Injector with Needle Guard



2mL Injector Dose Range: 1mL – 2mL
Dose Increments: 0.1mL
5mL Injector Dose Range: 1mL – 2mL
Dose Increments: 0.5mL

850 0004-130 TF
850 0004-131 TF
850 0004-132 TF
850 0004-133 TF
850 0004-134 BM
850 0004-135 BM
850 0004-136 BM
850 0004-137 BM

ACCESSORIES

15mL PowerMaster Tube Fed Major Kit



Includes: Cylinder (Barrel); O-rings; Value & Spring
850 0000-233

50mL PowerMaster Oral Drencher Major Kit

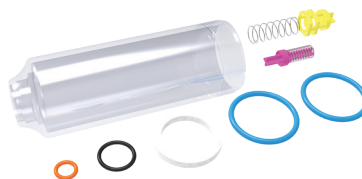

Includes: Cylinder (Barrel); O-rings; Value & Spring
850 0000-148

65mL PowerMaster Pour-on Major Kit



Includes: Cylinder (Barrel); O-rings; Values & Springs
850 0000-139

POWERMASTER ASSEMBLY

1. Connect the feed tube to the PowerMaster
2. Connect the air supply from the compressor
3. Prime the PowerMaster and it's ready to operate

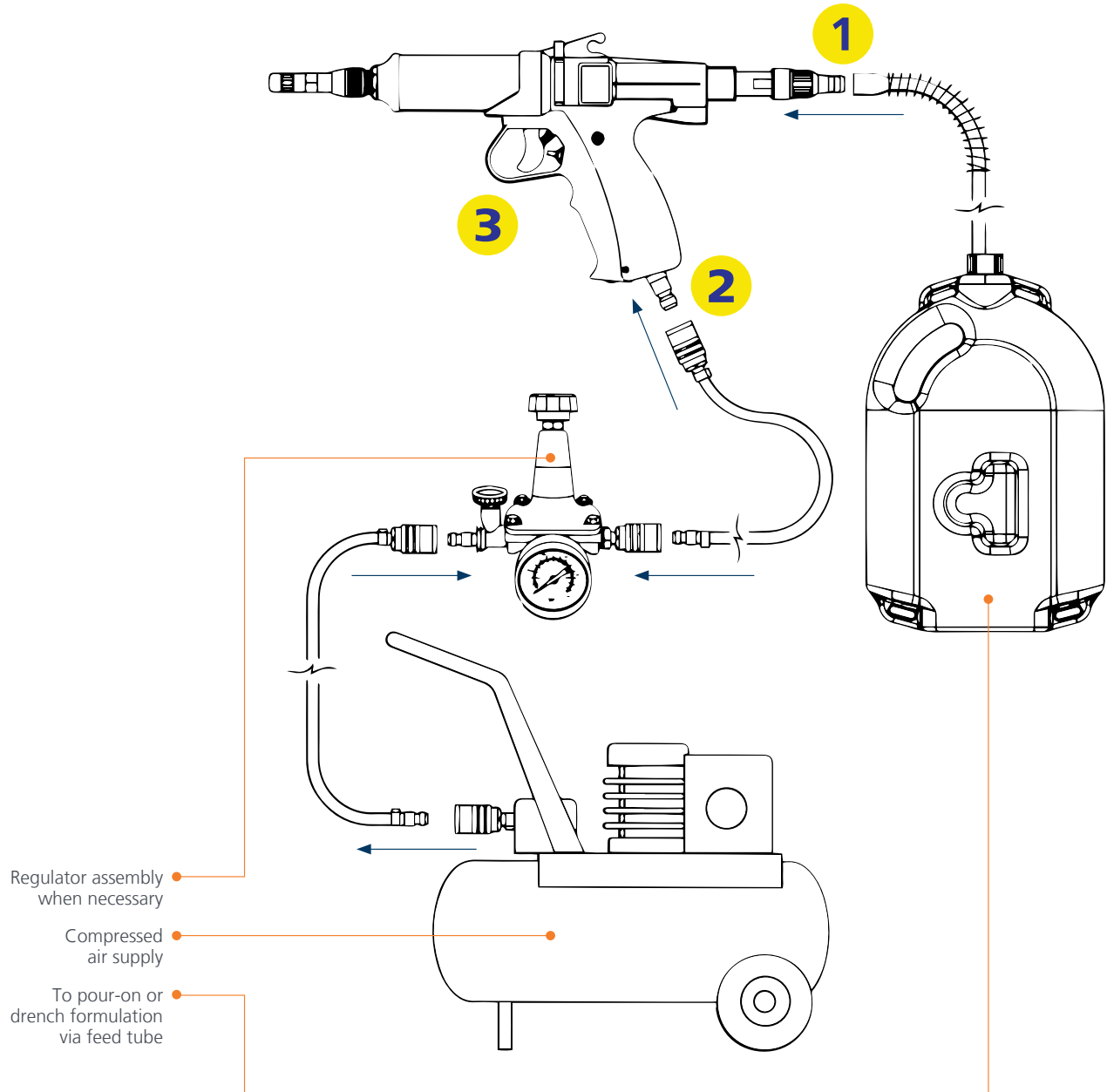

See instructional manual for full details on operating this device.

2.5L Backpack: 850 0000-068
5L Backpack: 850 0000-069

Choosing the Correct Needle or Syringe

Needle and syringe sizes vary based on factors like animal species, size, and injection type.

1 What type of injection or route of administration does the vaccine or treatment product require?

- Intramuscular (IM): Neck or Shoulder muscle
- Subcutaneous (SQ): Space under the skin

2 Type of Needle: Aluminum Hub vs Polypropylene Hub

- Aluminum Hub: Durable, Multi-Use
- Polypropylene Hub: Single Injections, Small Animal & Equine

3 Type of Syringe

- Luer Lock: Secure connection by threading for a "locking" fit onto the syringe.
- Luer Slip: Quick to change, push on friction-fit connection.
- Catheter Tip: Used for flushing/cleaning catheters, tubes, etc.

4 Determine Needle Size

	SUBCUTANEOUS (SQ)		INTRAMUSCULAR (IM)	
	Gauge	Length	Gauge	Length
Small Animal	22	3/4"	22	1"
Sheep & Goat	20	1/2" - 3/4"	20	1" - 1 1/2"
Swine	18	1/2" - 3/4"	18	1" - 1 1/2"
Piglets	20	1/2"	20	3/4"
Cow	16	3/4" - 1"	16	1" - 1 1/2"
Calf	18	3/4"	18	1"
Equine	20	1"	20	1" - 1 1/2"
Foal	20	3/4"	20	1"

Basic Injection tips

- Always follow label instructions on the product label for proper dosage and administration.
- Ensure a clean and dry injection site to prevent infections.
- Clean the animal's injection site to avoid contamination.
- Choose the smallest practical needle size based on animal size and consider the product viscosity when selecting needle gauge.
- Space multiple injections across several inches or inject different sides of the animal to avoid concentration in one area.

NOTE: The information shown here has been gathered from many sources and with great care. We always recommend consulting your veterinarian about proper and safe injection administration.

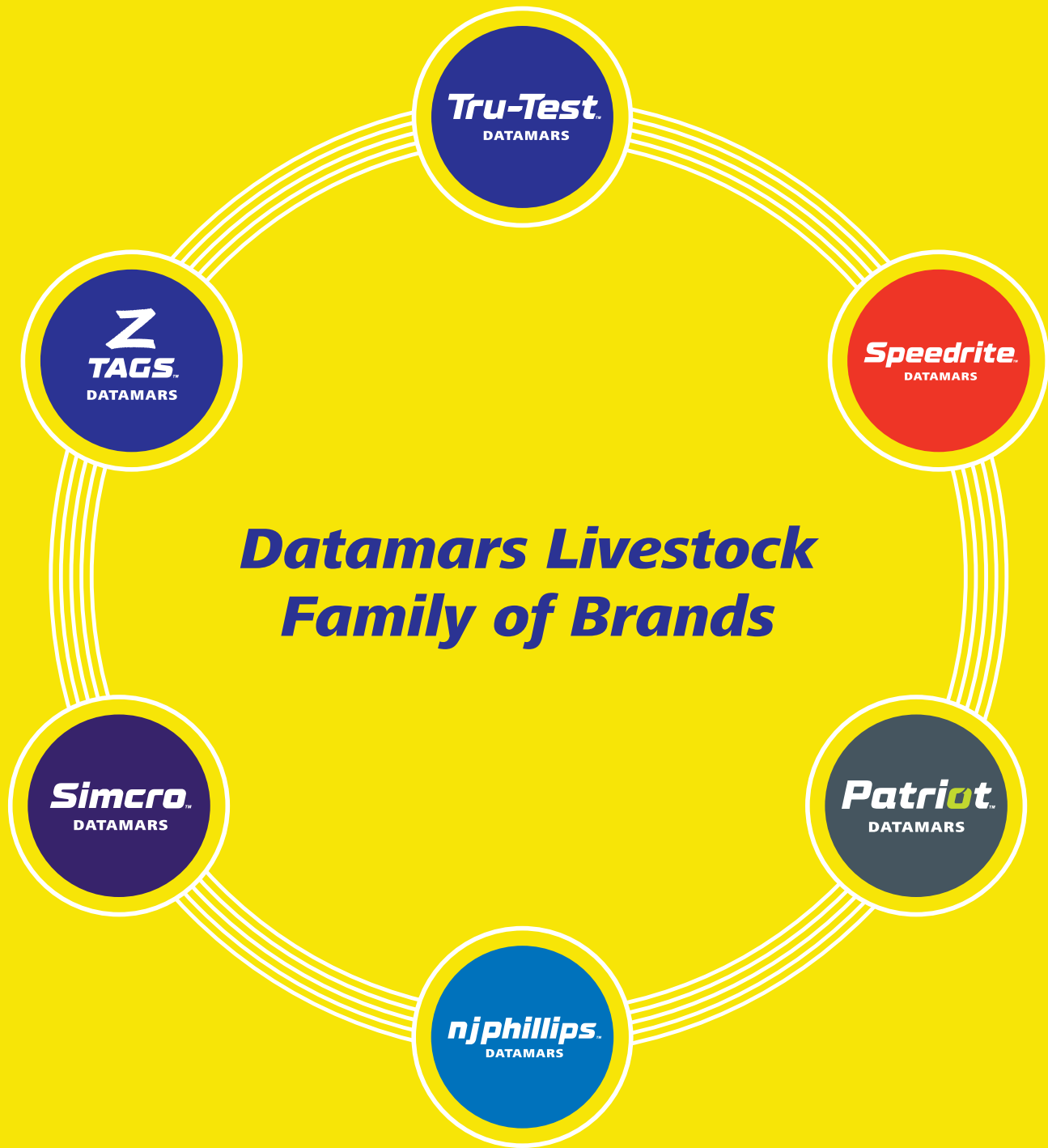

DATAMARS
Livestock



DatamarsLivestockNA



datamarslivestock_northamerica

Tru-Test, Z Tags, Temple Tag, Patriot, Speedrite, NJ Phillips and Simcro are registered trademarks of Datamars, Inc. Although the information presented is believed to be accurate and reliable, no responsibility for inaccuracies can be assumed by Datamars, Inc. Performance data is typical only and variations due to component manufacturing tolerances are normal. Datamars, Inc. reserves the right at any time to change performance characteristics or specifications without prior notice. ©2024 Datamars, Inc. – All rights reserved.